

Gama milimétrica de acero inoxidable

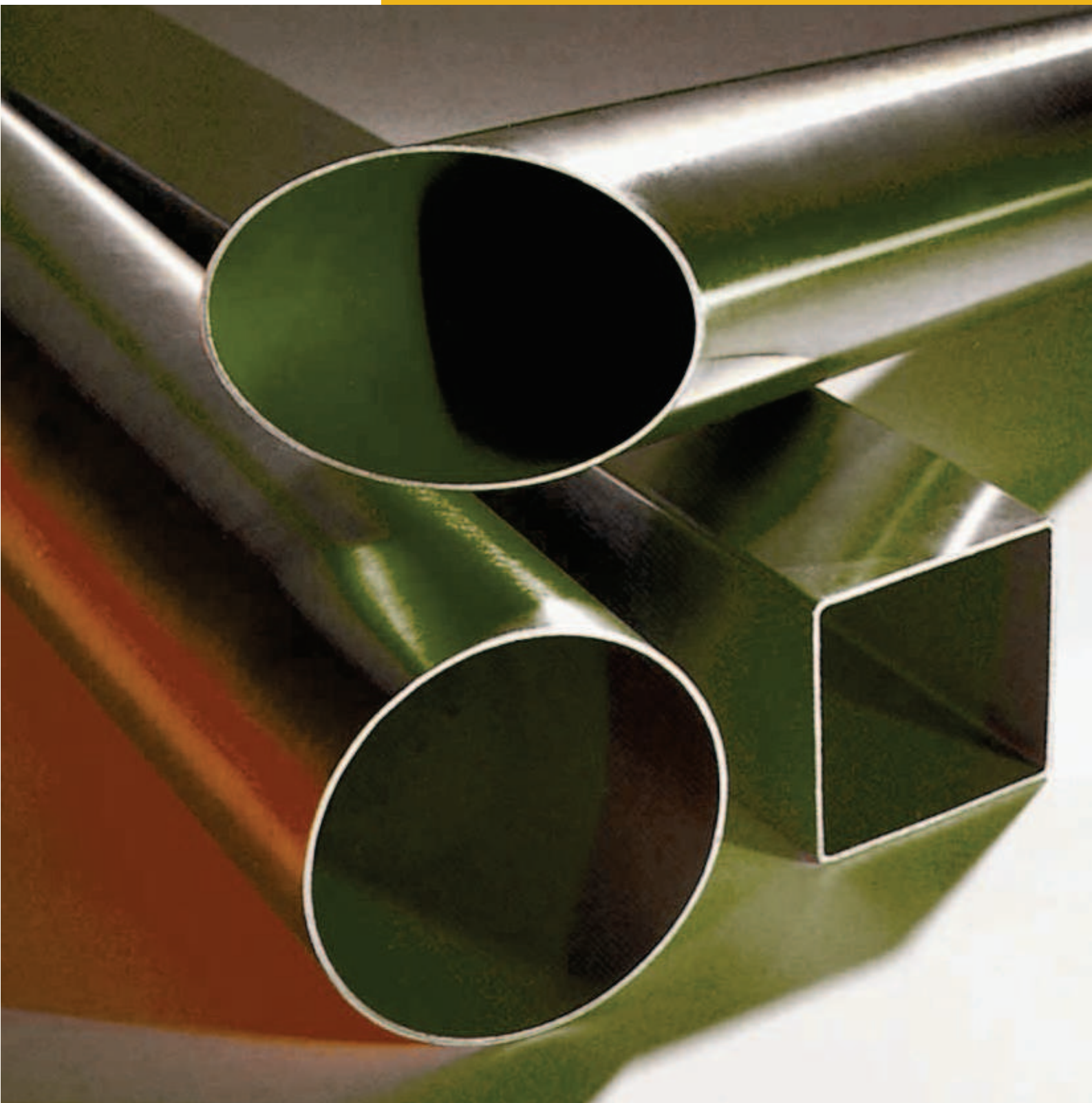

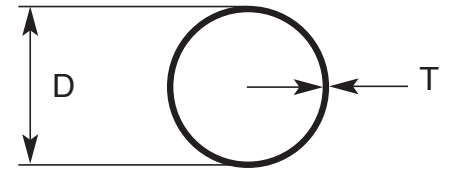

Tubos soldados milimétricos



Peso teórico de los tubos Kg/m

Diámetro exterior mm	Espesor mm													
	0,80	1	1,2	1,5	1,6	2	2,5	2,6	3	3,2	3,6	4	5	6
6		0,125												
8	0,144	0,175												
10	0,184	0,225	0,264	0,319										
12	0,224	0,275	0,325	0,394	0,417	0,501								
14	0,264	0,326	0,385	0,470	0,497	0,601								
15	0,284	0,351	0,415	0,507	0,537	0,651								
16	0,304	0,376	0,445	0,545	0,577	0,701								
18	0,345	0,426	0,505	0,620	0,657	0,801	0,970	1,003	1,127					
19	0,365	0,451	0,535	0,657	0,697	0,851	1,033	1,068	1,202					
20	0,385	0,476	0,565	0,695	0,737	0,901	1,096	1,133	1,277					
22	0,425	0,526	0,625	0,770	0,817	1,002	1,221	1,263	1,427					
23	0,445	0,551	0,655	0,808	0,857	1,052	1,283	1,328	1,502					
24	0,465	0,576	0,685	0,845	0,897	1,102	1,346	1,393	1,578					
25	0,485	0,601	0,715	0,883	0,937	1,152	1,409	1,458	1,653					
28	0,545	0,676	0,805	0,995	1,058	1,302	1,596	1,654	1,878					
29	0,565	0,701	0,835	1,033	1,098	1,352	1,659	1,719	1,953					
30	0,585	0,726	0,865	1,070	1,138	1,402	1,722	1,784	2,028					
32	0,625	0,776	0,925	1,146	1,218	1,502	1,847	1,914	2,178					
33	0,645	0,801	0,956	1,183	1,258	1,552	1,909	1,979	2,254					
34	0,665	0,826	0,986	1,221	1,298	1,603	1,972	2,044	2,329	2,468				
35	0,685	0,851	1,016	1,258	1,338	1,653	2,035	2,109	2,404	2,548				
38	0,745	0,926	1,106	1,371	1,458	1,803	2,222	2,305	2,629	2,788	3,101	3,405		
40	0,785	0,977	1,166	1,446	1,538	1,903	2,348	2,435	2,779	2,949	3,281	3,606		
41		1,002	1,196	1,484	1,579	1,953	2,410	2,500	2,855	3,029	3,371	3,706		
42		1,027	1,226	1,521	1,619	2,003	2,473	2,565	2,930	3,109	3,462	3,806		
43		1,052	1,256	1,559	1,659	2,053	2,535	2,630	3,005	3,189	3,552	3,906		
44,5		1,089	1,301	1,615	1,719	2,128	2,629	2,728	3,117	3,309	3,687	4,056		
45		1,102	1,316	1,634	1,739	2,153	2,661	2,760	3,155	3,349	3,732	4,107		
48		1,177	1,406	1,747	1,859	2,304	2,848	2,956	3,380	3,590	4,002	4,407		
50		1,227	1,466	1,822	1,939	2,404	2,974	3,086	3,531	3,750	4,183	4,607		
50,8		1,247	1,490	1,852	1,971	2,444	3,024	3,138	3,591	3,814	4,255	4,687		
51		1,252	1,496	1,859	1,979	2,454	3,036	3,151	3,606	3,830	4,273	4,708		
52		1,277	1,526	1,897	2,019	2,504	3,099	3,216	3,681	3,910	4,363	4,808		
53		1,302	1,556	1,934	2,059	2,554	3,161	3,281	3,756	3,990	4,453	4,908		
54		1,327	1,587	1,972	2,099	2,604	3,224	3,346	3,831	4,071	4,543	5,008		
55		1,352	1,617	2,009	2,139	2,654	3,287	3,411	3,906	4,151	4,633	5,108		
57		1,402	1,677	2,085	2,220	2,754	3,412	3,542	4,056	4,311	4,814	5,308		
63,5		1,565	1,872	2,329	2,480	3,080	3,819	3,965	4,545	4,832	5,400	5,960	7,324	
70		1,728	2,067	2,573	2,740	3,405	4,226	4,388	5,033	5,353	5,986	6,611	8,138	
73		1,803	2,157	2,686	2,861	3,556	4,413	4,583	5,258	5,593	6,256	6,911	8,514	
76,1		1,881	2,251	2,802	2,985	3,711	4,607	4,785	5,491	5,841	6,535	7,222	8,902	
80		1,978	2,368	2,948	3,141	3,906	4,852	5,039	5,784	6,154	6,887	7,612	9,390	
83		2,053	2,458	3,061	3,261	4,056	5,039	5,234	6,010	6,394	7,157	7,913	9,766	
84		2,078	2,488	3,099	3,301	4,107	5,102	5,299	6,085	6,474	7,248	8,013	9,891	
85		2,103	2,518	3,136	3,341	4,157	5,165	5,365	6,160	6,554	7,338	8,113	10,016	

Composición química: Ver página 8

Características mecánicas: Ver página 9

Calidad del material: AISI 304/304L, 316/316L, duplex

Acabados: Ver página 13

Tolerancias: Ver página 33

Normas de fabricación: EN 10217-7 y EN 10296-2

Longitud de suministro: 6.000 mm.

Otros largos, espesores, calidades o características especiales bajo pedido especial (consultar).

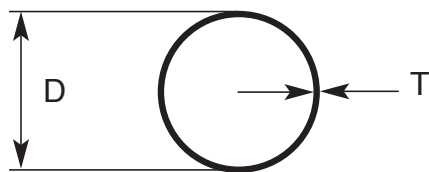

Tubos soldados milimétricos

Peso teórico de los tubos Kg/m

Diámetro exterior mm	Espesor mm													
	0,80	1	1,2	1,5	1,6	2	2,5	2,6	3	3,2	3,6	4	5	6
95				3,512	3,742	4,657	5,791	6,016	6,911	7,356	8,239	9,115	11,268	
103				3,812	4,062	5,058	6,291	6,536	7,512	7,997	8,960	9,916	12,270	
104				3,850	4,103	5,108	6,354	6,602	7,587	8,077	9,050	10,016	12,395	
108				4,000	4,263	5,308	6,604	6,862	7,888	8,397	9,411	10,417	12,896	
127				4,714	5,024	6,260	7,794	8,099	9,315	9,920	11,124	12,320	15,274	18,179
129				4,789	5,104	6,360	7,919	8,229	9,465	10,080	11,304	12,520	15,525	18,480
133				4,939	5,264	6,560	8,169	8,490	9,766	10,401	11,665	12,921	16,026	19,080
153				5,690	6,066	7,562	9,421	9,792	11,268	12,003	13,468	14,924	18,530	22,085
154				5,728	6,106	7,612	9,484	9,857	11,343	12,083	13,558	15,024	18,655	22,236
155				5,765	6,146	7,662	9,547	9,922	11,418	12,163	13,648	15,124	18,780	22,386
156				5,803	6,186	7,712	9,609	9,987	11,493	12,244	13,738	15,224	18,905	22,536
159				5,916	6,306	7,863	9,797	10,182	11,719	12,484	14,008	15,525	19,281	22,987
204				7,606	8,109	10,116	12,614	13,112	15,099	16,090	18,065	20,032	24,915	29,748
205				7,643	8,149	10,166	12,677	13,177	15,174	16,170	18,155	20,132	25,040	29,898
206						10,216	12,739	13,242	15,249	16,250	18,245	20,232	25,165	30,048
254						12,620	15,744	16,367	18,855	20,096	22,572	25,040	31,175	37,260
255						12,670	15,807	16,432	18,930	20,176	22,662	25,140	31,300	37,410
256						12,720	15,869	16,497	19,005	20,256	22,752	25,240	31,425	37,560
304						15,124	18,874	19,622	22,611	24,103	27,079	30,048	37,435	44,772
306						15,224	18,999	19,753	22,761	24,263	27,260	30,248	37,685	45,072
354						17,708	22,104	22,982	26,487	28,237	31,731	35,216	43,895	52,524
406						20,252	25,284	26,289	30,303	32,308	36,310	40,304	50,255	60,156
456									34,000	36,320	40,820	45,320		
506							31,644	32,904	37,936	40,449	45,469	50,481	62,976	75,420

Tubos soldados

(espesor de pared < 1mm)

Peso teórico de los tubos Kg/m

Diámetro exterior mm	Espesor mm					
	0,40	0,50	0,60	0,70	0,75	0,80
5	0,046	0,056	0,066	0,075	0,080	
6	0,056	0,069	0,081	0,093	0,099	
7,50	0,071	0,088	0,104	0,119	0,127	
8	0,076	0,094	0,111	0,128	0,136	0,144
9,50	0,091	0,113	0,134	0,154	0,164	0,174
10	0,096	0,119	0,141	0,163	0,174	0,184
12	0,116	0,144	0,171	0,198	0,211	0,224
12,70	0,123	0,153	0,182	0,210	0,224	0,238
13	0,126	0,157	0,186	0,216	0,230	0,244
14	0,136	0,169	0,201	0,233	0,249	0,264
15	0,146	0,182	0,216	0,251	0,268	0,284
16	0,156	0,194	0,231	0,268	0,286	0,304
17,20	0,168	0,209	0,249	0,289	0,309	0,329
18	0,176	0,219	0,261	0,303	0,324	0,345
19	0,232	0,276	0,321	0,343	0,365	
19,05	0,232	0,277	0,322	0,344	0,366	
20	0,244	0,291	0,338	0,362	0,385	



Codos 90° soldados

Accesorios de acero inoxidable para soldar

Diámetro exterior D mm	Radio R=F mm	Espesor T mm	Peso Kg
18	25	1,5	0,02
20	30	1,5	0,03
23	35	1,5	0,04
25	37	1,5	0,05
28	40	1,5	0,06
30	45	1,5	0,07
33	50	1,5	0,08
35	52,5	1,5	0,10
38	55	1,5	0,11
43	65	1,5	0,15
44,5	65	2,0	0,21
50,8	76	1,5	0,22
53	80	1,5	0,24
63,5	95	1,5	0,34
73	110	1,5	0,40
76	115	1,5	0,50
84	125	2,0	0,76
104	155	2,0	1,20
129	190	2,0	1,90
154	225	2,0	2,69
156	225	3,0	3,90
204	300	2,0	4,80
206	300	3,0	7,30
254	350	2,0	7,42
256	350	3,0	10,50
304	400	2,0	9,6
306	400	3,0	14,4
355	450	2,5	16,0
356	450	3,0	19,0
406	500	3,0	29,0
456	675	3,0	37,0
506	750	3,0	45,0
606	900	3,0	66,0

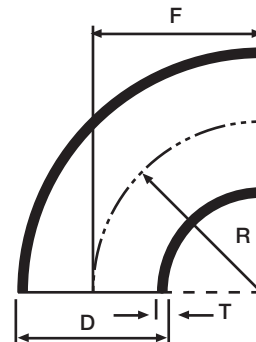

Calidad del material:

AISI-304, 316, 304 L, 316 L, duplex

Composición química: ver página 8.

Características mecánicas: ver página 9.

Tolerancias: ver página 34.

Normas de fabricación:

EN 10253-3/EN 10253-4.

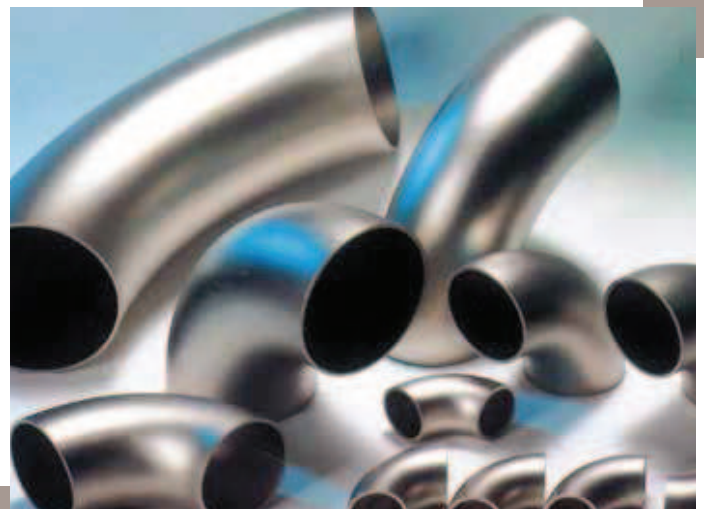



Valonas

Accesorios de acero inoxidable para soldar

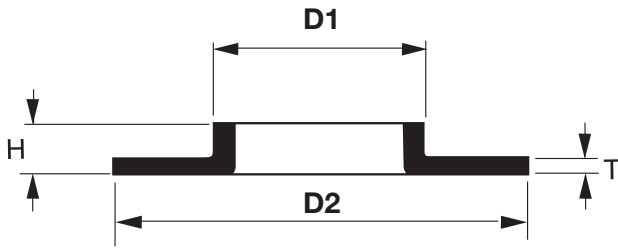

D1 mm	D2 mm	H mm	T mm	Peso Kg
18	42	6	1,5	0,028
20	51	7	1,5	0,035
23	58	7	1,5	0,037
25	58	7	1,5	0,034
28	68	8	1,5	0,048
30	68	8	1,5	0,045
33	68	9	1,5	0,061
38	78	10	1,5	0,061
43	88	10	1,5	0,076
50,8	102	11	1,5	0,100
53	102	12	1,5	0,112
63,5	102	13	1,5	0,123
73	122	12	1,5	0,130
76	122	12	1,5	0,223
84	138	13	2	0,186
104	158	16	2	0,237
129	188	15	2	0,313
154	212	19	2	0,378
204	268	21	2	0,543
254	320	24	2	0,711
304	370	21	2	0,804
354	430	21	2	1,244
406	482	21	3	1,770
456	532	25	3	2,087
506	585	25	3	2,286
606	685	25	3	2,719

Especificación del producto: EN 1092-1 Tipo 33.

Calidad del material: AISI-304/304-L, 316/316-L, duplex.

Composición química: Ver página 8.

Características mecánicas: Ver página 9.

Tolerancias: Ver página 34.

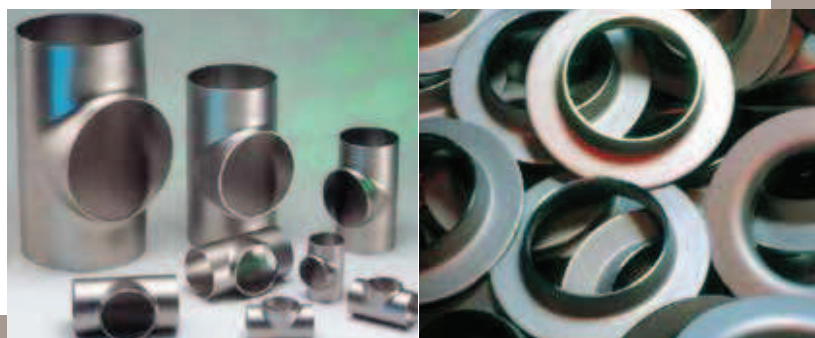



Tes iguales

Accesorios de acero inoxidable para soldar

D mm	F mm	T mm	Peso Kg
18	25,5	1,5	0,038
20	25,5	1,5	0,042
23	25,5	1,5	0,047
25	28,5	1,5	0,056
28	28,5	1,5	0,067
30	38	1,5	0,110
33	38	1,5	0,140
38	47,5	1,5	0,181
43	47,5	1,5	0,223
50,8	57	1,5	0,239
53	57	1,5	0,242
63,5	63,5	1,5	0,353
73	76	1,5	0,580
76	76	1,5	0,668
84	85,5	2	0,772
104	105	2	1,191
129	124	2	1,760
154	143	2	2,800
204	178	2	3,836
254	250	2	7,210
304	300	2	11,100
354	350	2	15,000
356	350	3	22,800
406	400	3	28,200
456	450	3	36,300
506	500	3	46,700
606	600	3	68,370

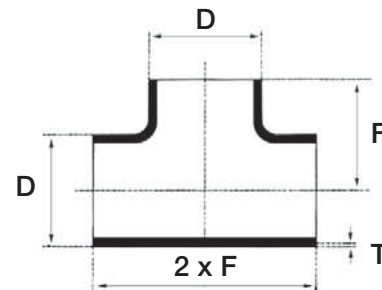

Norma de fabricación: EN 10253-3/EN 10253-4.

Calidad del material: AISI-304/304-L, 316/316-L, duplex.

Composición química: Ver página 8.

Características mecánicas: Ver página 9.

Tolerancias: Ver página 34.





CAPS

Accesorios de acero inoxidable para soldar

D mm	T mm	K mm	Peso Kg
18	1,5	13	0,009
20	1,5	12	0,011
23	1,5	12	0,014
25	1,5	12	0,016
28	1,5	12	0,022
30	1,5	12	0,024
33	1,5	12	0,025
38	1,5	15	0,034
43	1,5	16	0,040
50,8	1,5	19	0,055
53	1,5	19	0,058
63,5	1,5	19	0,076
73	1,5	21	0,150
76	2	28	0,198
84	2	23	0,131
104	2	24	0,187
129	2	34	0,314
154	2	41	0,444
204	2	50	0,754
206	3	50	1,130
254	2	55	1,078
256	3	55	1,620
304	2	68	1,646
306	3	70	2,470
354	2	84	2,344
356	3	89	3,520
406	3	98	4,523
456	3	108	5,494
506	3	120	6,558
606	3	140	9,232

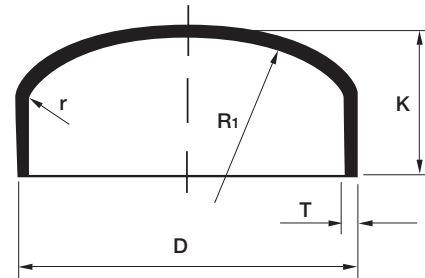

Radio mayor (R1)= Aproximadamente 0,8 D

Radio pequeño (r)= Aproximadamente 0,15 D

Calidad del material:

AISI-304/304-L, 316/316-L, duplex.

Composición química: Ver página 8**Características mecánicas:** Ver página 9**Tolerancias:** Ver página 34.**Normas de fabricación:** EN 10253-3/EN 10253-4.

Dimens. Nominal	Diámetro ext. tubo	B mm	C mm	E mm	R mm
1/8"	10,5	29	14,5	13	4 x 070
1/4"	14	32	20	14	6 x 100
3/8"	17,5	37	23,5	15	6 x 100
1/2"	22	42	28	17	6 x 100
3/4"	28	50	34	19	6 x 100
1"	35	62	41	24	6 x 100
1 1/4"	43	71	49	24	6 x 100
1 1/2"	49	80	57	26	8 x 125
2"	62	91	70	26	8 x 125
2 1/2"	75	117,5	85	35	10 x 150
3"	90,5	130,5	100,5	35	10 x 150
3 1/2"	104	143	114	35	10 x 150
4"	117	155	127	35	10 x 150
5"	144	186	154	40	10 x 150
6"	171	213	181	40	10 x 150
8"	222	264	232	40	10 x 150
10"	276	318	286	40	10 x 150
12"	327	378	339	50	14 x 200
14"	360	410	372	50	14 x 200
16"	410	470	422	60	14 x 200
18"	462	532	476	70	16 x 200
20"	515	585	529	70	16 x 200

Abarcones

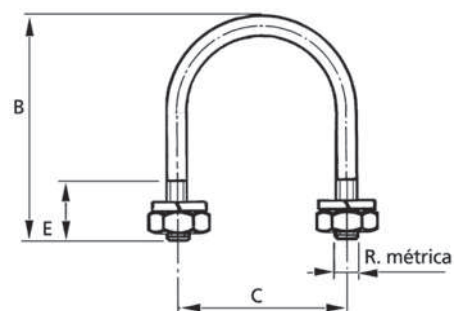
**Material:** Acero inoxidable.

Bajo pedido pueden suministrarse con tuerca y contratuerca en lugar de arandela Groover



Reducciones concéntricas y excéntricas

Accesorios de acero inoxidable para soldar

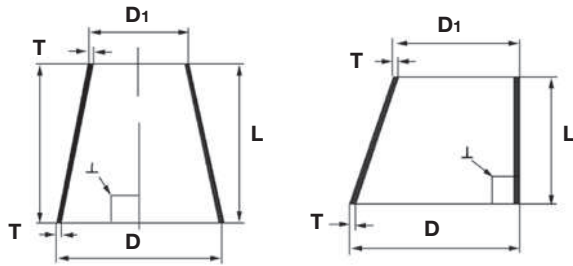

D mm	D1 mm	L mm	T mm	Peso kg
18	13	15	1,5	0,009
19	14	15	2	0,012
23	13	20	1,5	0,014
24	14	20	2	0,019
23	18	20	1,5	0,015
24	19	20	2	0,022
28	18	25	1,5	0,022
29	19	25	2	0,030
28	23	25	1,5	0,024
29	24	25	2	0,033
33	18	30	1,5	0,029
34	19	30	2	0,040
33	23	30	1,5	0,032
34	24	30	2	0,044
33	28	30	1,5	0,034
34	29	30	2	0,047
35	23	32	1,5	0,035
36	24	32	2	0,048
35	28	32	1,5	0,038
36	29	32	2	0,052
35	33	32	1,5	0,041
36	34	32	2	0,056
38	18	32	1,5	0,034
39	19	32	2	0,047
38	23	32	1,5	0,037
39	24	32	2	0,051
38	28	32	1,5	0,040
39	29	32	2	0,055
38	33	32	1,5	0,043
39	34	32	2	0,059
38	35	32	1,5	0,044
39	36	32	2	0,060
43	23	40	1,5	0,050
44	24	40	2	0,068
43	28	40	1,5	0,054
44	29	40	2	0,073
43	33	40	1,5	0,057
44	34	40	2	0,078
43	35	40	1,5	0,059
44	36	40	2	0,080
43	38	40	1,5	0,061
44	39	40	2	0,083
53	28	50	1,5	0,076
54	29	50	2	0,104
53	33	50	1,5	0,081
54	34	50	2	0,111
53	35	50	1,5	0,083
54	36	50	2	0,113
53	38	50	1,5	0,086

D mm	D1 mm	L mm	T mm	Peso kg
54	39	50	2	0,117
53	43	50	1,5	0,090
54	44	50	2	0,123
63	28	65	1,5	0,111
64	29	65	2	0,152
63	33	65	1,5	0,118
64	34	65	2	0,160
63	35	65	1,5	0,120
64	36	65	2	0,163
63	38	65	1,5	0,124
64	39	65	2	0,168
63	43	65	1,5	0,130
64	44	65	2	0,176
63	53	65	1,5	0,142
64	54	65	2	0,193
68	33	65	1,5	0,124
69	34	65	2	0,168
68	35	65	1,5	0,126
69	36	65	2	0,171
68	38	65	1,5	0,130
69	39	65	2	0,176
68	43	65	1,5	0,136
69	44	65	2	0,185
68	53	65	1,5	0,148
69	54	65	2	0,201
68	63	65	1,5	0,160
69	64	65	2	0,217
74	44	65	2	0,193
74	54	65	2	0,209
74	64	65	2	0,225
84	44	80	2	0,257
86	46	80	3	0,398
84	54	80	2	0,277
86	56	80	3	0,428
84	64	80	2	0,297
84	69	80	2	0,307
86	71	80	3	0,473
104	44	100	2	0,372
106	46	100	3	0,573
104	54	100	2	0,397
106	56	100	3	0,610
104	69	100	2	0,435
106	71	100	3	0,667
104	74	100	2	0,447
104	84	100	2	0,472
106	86	100	3	0,723
129	54	125	2	0,575
131	56	125	3	0,881
129	69	125	2	0,622
131	71	125	3	0,951
129	74	125	2	0,637
129	84	125	2	0,669
131	86	125	3	1,022
129	104	125	2	0,732
131	106	125	3	1,116
154	54	150	2	0,784
156	56	150	3	1,198
154	69	150	2	0,840



Reducciones concéntricas y excéntricas

Accesorios de acero inoxidable para soldar

D mm	D ₁ mm	L mm	T mm	Peso kg
156	71	150	3	1,283
154	84	150	2	0,897
156	86	150	3	1,368
154	104	150	2	0,972
156	106	150	3	1,481
154	129	150	2	1,066
156	131	150	3	1,622
204	69	200	2	1,372
206	71	200	3	2,087
204	84	200	2	1,447
206	86	200	3	2,201
204	104	200	2	1,547
206	106	200	3	2,351
204	129	200	2	1,673
206	131	200	3	2,540
204	154	200	2	1,799
206	156	200	3	2,728
254	104	250	2	2,248
256	106	250	3	3,410
254	129	250	2	2,405
256	131	250	3	3,646
254	154	250	2	2,562
256	156	250	3	3,881
254	204	250	2	2,876
256	206	250	3	4,352
304	204	300	2	3,828
306	206	300	3	5,788
304	254	300	2	4,205
306	256	300	3	6,353
356	206	350	3	7,412
358	208	350	4	9,953
356	256	350	3	8,071
358	258	350	4	10,832
356	306	350	3	8,730
358	308	350	4	11,711
406	206	400	3	9,224
408	208	400	4	12,379
406	256	400	3	9,978
408	258	400	4	13,384
406	306	400	3	10,731
408	308	400	4	14,389
406	356	400	3	11,485
408	358	400	4	15,394
458	258	450	4	16,187
458	308	450	4	17,318
458	358	450	4	18,448
458	408	450	4	19,579
506	256	500	3	14,356
506	306	500	3	15,298
506	356	500	3	16,240
506	406	500	3	17,182
506	456	500	3	18,124
606	306	600	3	20,618
608	308	600	4	27,612
606	356	600	3	21,749
608	358	600	4	29,119
606	406	600	3	22,879
608	408	600	4	30,626

D mm	D ₁ mm	L mm	T mm	Peso kg
606	456	600	3	24,010
608	458	600	4	32,134
606	506	600	3	25,140
608	508	600	4	33,641
706	356	700	3	28,011
708	358	700	4	37,489
706	406	700	3	29,330
708	408	700	4	39,247
706	456	700	3	30,649
708	458	700	4	41,006
706	506	700	3	31,968
708	508	700	4	42,764
706	606	700	3	34,605
708	608	700	4	46,281
806	406	800	3	36,535
808	408	800	4	48,873
806	456	800	3	38,042
808	458	800	4	50,883
806	506	800	3	39,549
808	508	800	4	52,893
806	606	800	3	42,563
808	608	800	4	56,912
906	456	900	3	46,188
908	458	900	4	61,765
906	506	900	3	47,884
908	508	900	4	64,026
906	606	900	3	51,275
908	608	900	4	68,547
906	706	900	3	54,666
908	708	900	4	73,069
906	806	900	3	58,057
908	808	900	4	77,591

D y D₁ son diámetros exteriores

Calidad del material: AISI-304/304-L, 316/316-L, duplex.

Composición química: Ver página 8.

Características mecánicas: ver página 9.

Tolerancias: Ver página 34.

Normas de fabricación: EN 10253-3/EN 10253-4.

